



E Series



100W, 200W & 300W High lumen LED sports Stadium & Area lights



Key Features:

- IP65 rated for external applications
- Project product can be mounted in multiple modules mounted on a single heavy duty bracket
- E series lights are a project product on a fixed bracket for use in interior or exterior environments.
- Universal input 90 ~ 305Vac 50/60Hz using  Meanwell HLG drivers.
- LED life of 50,000 hours
- Easy installation & low maintenance
- Available in colour temperatures of 2700 ~ 6500K (standard 5700K)
- 5 years warranty
- Using Philips LUMILEDS LED chip 

E SERIES 100W SPECIFICATION

Part Code	E Series-100W
Fitting Colour	Black
Input Voltage	90-305V
Output Load	100W
Power Factor	>0.95
Lumens	12600lm
Beam Angle	25°/30°/45°/60°/90°/120°
Colour (K)	5700K
CRI	>80Ra
Efficacy (lm/W)	126lm/W
Working Temperature	-30°C ~ +50°C
Protection	IP65
Weight	3.8kg
Dimensions	272 x 157 x 84mm

E SERIES 200W SPECIFICATION

Part Code	E Series-200W
Fitting Colour	Black
Input Voltage	90-305V
Output Load	200W
Power Factor	>0.95
Lumens	25200lm
Beam Angle	25°/30°/45°/60°/90°/120°
Colour (K)	5700K
CRI	>80Ra
Efficacy (lm/W)	126lm/W
Working Temperature	-30°C ~ +50°C
Protection	IP65
Weight	8.25kg
Dimensions	272 x 199 x 157mm

Mechanical Diagrams



E Series 100W

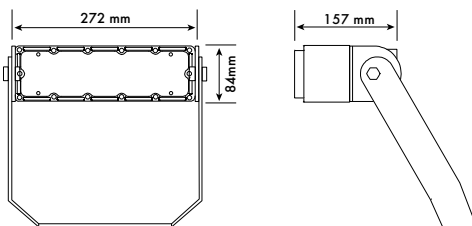

E Series 200W

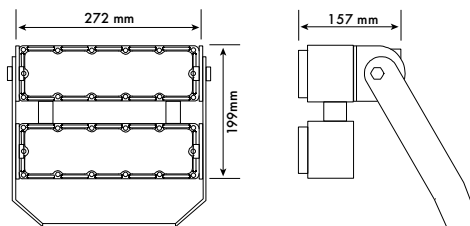

PowerLed (UK) Ltd
Orion House
Calleva Park
Aldermaston
Berkshire
RG7 8SN

Contact:
Tel: 0118 9703856
enquiries@powerled.uk.com
www.powerled.uk.com





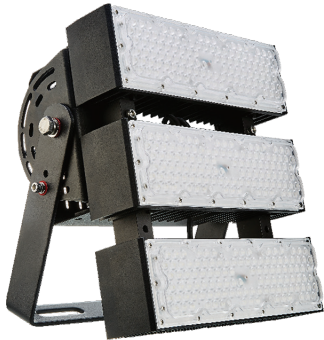

E Series

100W, 200W & 300W High lumen LED sports Stadium & Area lights



Key Features:

- IP65 rated for external applications
- Project product can be mounted in multiple modules mounted on a single heavy duty bracket
- E series lights are a project product on a fixed bracket for use in interior or exterior environments.
- Universal input 90 ~ 305Vac 50/60Hz using  Meanwell HLG drivers.
- LED life of 50,000 hours
- Easy installation & low maintenance
- Available in colour temperatures of 2700 ~ 6500K (standard 5700K)
- 5 years warranty
- Using Philips LUMILEDS LED chip 

E SERIES 300W SPECIFICATION

Part Code	E Series-300W
Fitting Colour	Black
Input Voltage	90-305V
Output Load	300W
Power Factor	>0.95
Lumens	37800lm
Beam Angle	25°/30°/45°/60°/90°/120°
Colour (K)	5700K
CRI	>80Ra
Efficacy (lm/W)	126lm/W
Working Temperature	-30°C ~ +50°C
Protection	IP65
Weight	8.7kg
Dimensions	272 x 314 x 181 mm

Mechanical Diagrams



E Series 300W

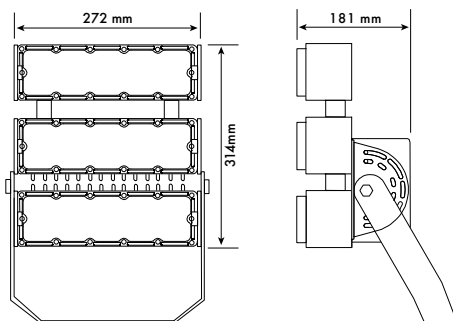

PowerLed (UK) Ltd
 Orion House
 Calleva Park
 Aldermaston
 Berkshire
 RG7 8SN

Contact:
 Tel: 0118 9703856
 enquiries@powerled.uk.com
 www.powerled.uk.com

