

# LED Light Bars - Connect

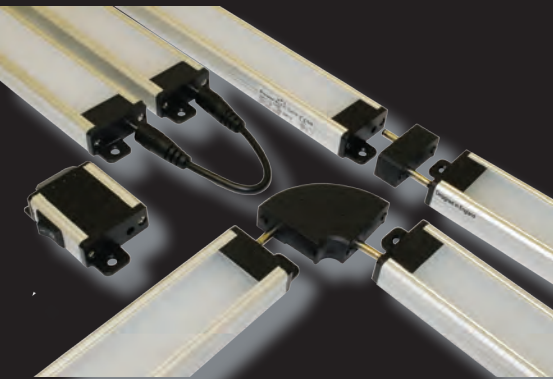

## Product Features

- ★ Slimline bar suitable for cabinet lighting, display and accent lighting etc.
- ★ Easy installation, multiple configurations
- ★ Simple and safe low voltage on/off control
- ★ Reverse polarity protected
- ★ Simple link up capability, allowing up to 4 metres of lighting from 1 driver
- ★ Rugged aluminium extrusion with easy fit mounting points
- ★ Suitable for 24VDC applications
- ★ Suitable for 24VDC vehicle applications
- ★ Constant power technology, ensures balanced light output across each fitting

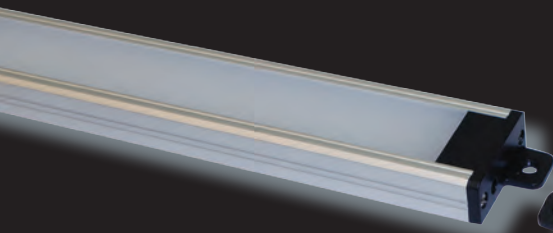

## Connect LED Light Bar

Part Code	CON210	CON210W	CON310	CON310W	CON510	CON510W
Lumen Output	280lm	225lm	420lm	350lm	620lm	520lm
Input Voltage	24VDC	24VDC	24VDC	24VDC	24VDC	24VDC
Current	125mA	125mA	200mA	200mA	350mA	350mA
Power	3W	3W	4.8W	4.8W	8.4W	8.4W
Power Consumption	3.2W	3.2W	5W	5W	9W	9W
LED Type	3528	3528	3528	3528	3528	3528
LED Qty	30	30	48	48	84	84
Light Length	200mm	200mm	300mm	300mm	500mm	500mm
Weight	62g	62g	94g	94g	155g	155g
Beam Angle	120°	120°	120°	120°	120°	120°
IP	IP44	IP44	IP44	IP44	IP44	IP44
CCT	6000 ~ 6500K	2700 ~ 2900K	6000 ~ 6500K	2700 ~ 2900K	6000 ~ 6500K	2700 ~ 2900K
Dimensions	223.6 x 30 x 12.3mm		323.6 x 30 x 12.3mm		523.6 x 30 x 12.3mm	



### Connect

#### CON210

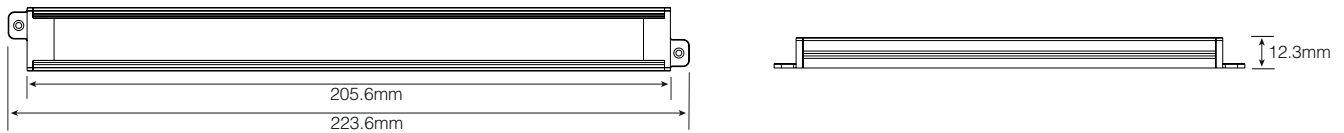

#### CON310

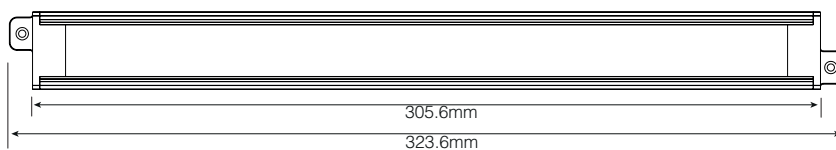

#### CON510

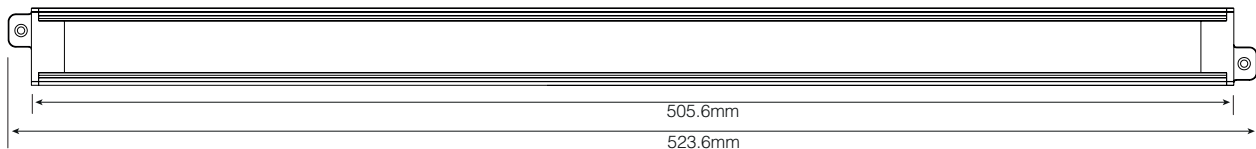

### Connect Luminance Distribution

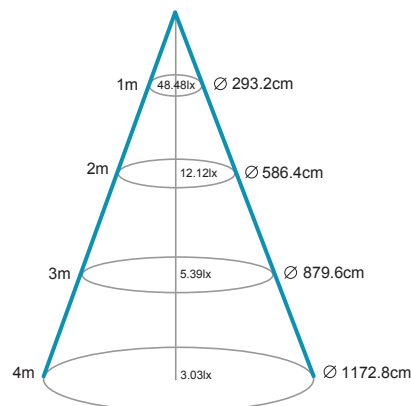
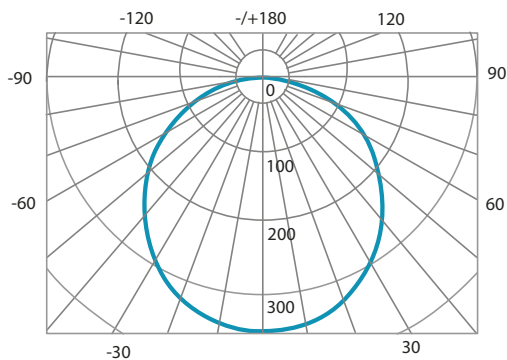

# Connect Connections

Part Code	F90	F180	S180	PS1	SW1	CLC-1	
Style	Corner	Straight	Cable	Cable	Switch	Connector Cable	
Max Current	3A	3A	3A	3A	3A	3A	All connector dimensions are 3.5Ømm O/D x 1.35Ømm I/D x 11mm long
Angle	90°	-	Flexible	Flexible	-	Flexible	
Weight	-	17g	6g	7g	-	-	
Dimensions	-	-	80mm	500mm	-	1500mm	

## Connect Connectors

### F180

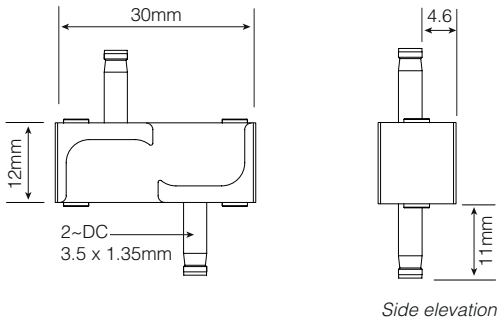

### SW1

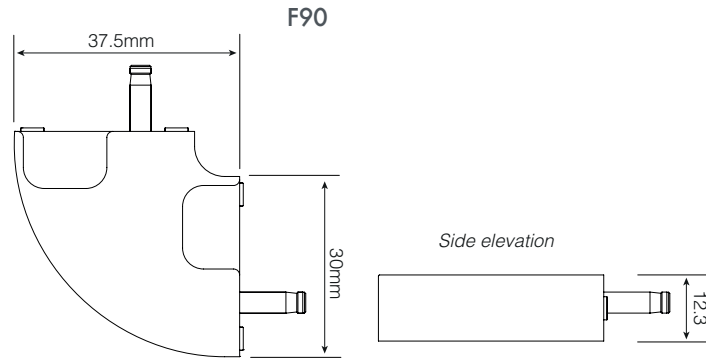
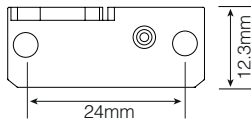
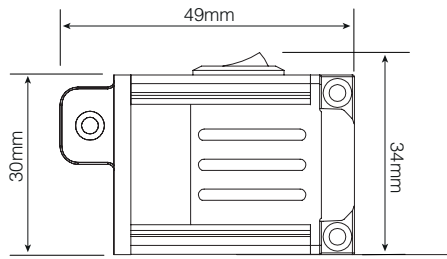

### PS1

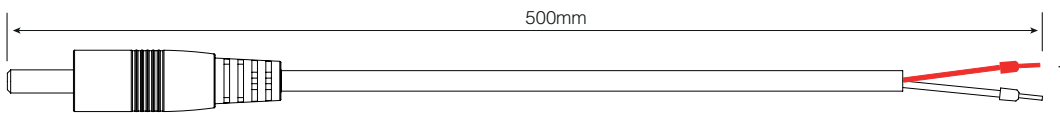

### S180

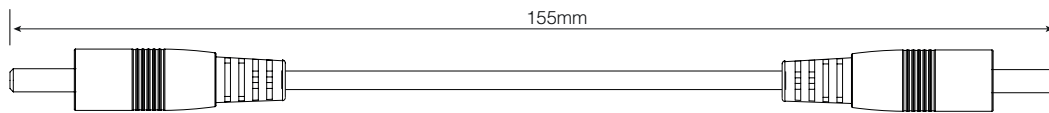

### CLC-1

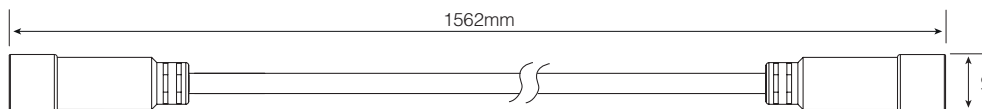

## Connect Connections

### CLC-1 Extender cable Connector

This new extender cable can be easily connected between led light bars to extend the overall desired length.



Use between two S180 cables or a combination of a S180 cable and a PS1 cable.

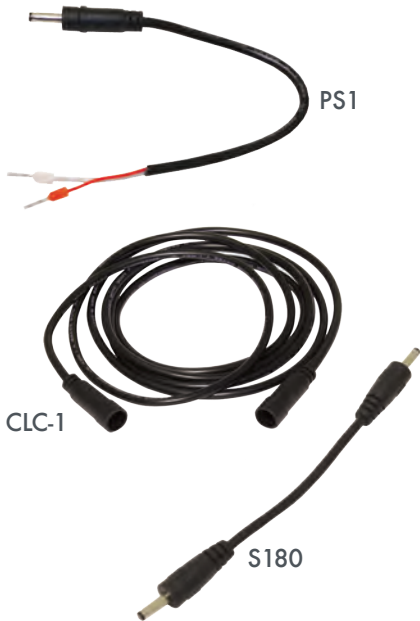

## Suggested LED Drivers

Part Code	PSU001	PSU002	PSU003	PSU004
Metres Powered	1.2mtr	2.1mtr	3mtr	4mtr

Maximum single run 4 metres when using standard PS1 input cable and F180 connections.

PowerLED Drivers and Connect connections must be used to provide power for the Connect series of LED Light Bars. Warranty will be void if alternative drivers or connections are used.

## IP Ratings explained



IP44 rated ~ Protected from granular foreign bodies >1mm.  
Protected from water splashing against the enclosure from any direction.

